



**WE ARE YOUR PARTNER
FOR CONNECTIVITY SOLUTIONS**

PRODUCT CATALOGUE



OUR STORY

KANTENNA was setup by a team of enthusiastic engineers who have extended experiences in the RF industry for decades. The company was registered in 2018 but our story began years before.

Back in early 2000, we had already been working with different operators and SI in the mobile communication sector. Our expertise has been gained through cooperation with operators throughout the APAC region.

Today we are serving most of the prestige system integrators and operators who have covered half of the world's population. We strive to create value added services to our customers in telecommunication industry and thereby increase the market share of our customers in their respective territories. Our advance product designs and market supports have been proved to be competitive.

We offer full range of products developed to provide suitable quality standards and technical requirements that are required by nowadays telecommunication market. KANTENNA solutions fulfill the market demands in both quality and cost competitiveness and support our customer to stay successful in the competitive environment of today and beyond.



OUR VISION

To become the preferred partner in supplying connectivity solutions.

OUR MISSION

We bring value to customers and all stakeholders by delivering innovative, efficient, high quality products and services in order to provide the best connectivity for a connected world through the drive and development of our team.

OUR VALUE

We strive to exceed expectations internally and externally by means of achieving extraordinary efficiency and effectiveness, along with having the customers and their needs in the centre of all of our activities. We focus on improving quality and safety of everyday life through a strategy of innovations, proposing products and services that meet and anticipate the needs of contemporary society.



OUR SOLUTIONS

We offer full range of outdoor RF components and indoor passive distribution system components encompassing to efficient RF networks for mobile communications as well as Wi-Fi connections and other radio frequency connectivity.

Mobile Cell Site Solutions

In addition to good quality BTS antenna, high quality cell site installation components are equally important to provide good coverage and high capacity network. KANTENNA provides most of the installation components from BTS antennas and eNode-B, including jumpers, adaptors, connectors, feeders, grounding kits, cable clamps and arrestors, SBT and control cables.

Indoor Distribution Solutions

Full range of DAS components from POI to antennas are available, including donor antennas, couplers and tappers, splitter, loads and attenuators, connectors and adaptors, antennas. Products of different performance are available to suit market expectation of cost and performance effectiveness.

Signal Processing Solutions

Standard and customized devices for RF signal processing are available: POI, multi-band and same-band combiners, multiplexer and filters. These are highly customized products to fit different markets. Our R&D team is well experienced in providing suitable solutions to meet customers' requirements.

Camouflage Site Solutions

In nowadays RF network, installations are very often close and fall within the visual contacts of the general public. Such scenarios have become more and more sensitive especially in the 5G era when more sites are required due to smaller cell coverage. Kantenna provides innovative approaches to reduce visual impact by concealing the network components with different housing. Some of the camouflages are combining actual functions with the RF antenna.

LIST OF PRODUCTS

Standard Passive Components

◆ Directional Couplers – 4000 series	6
◆ Hybrid Couplers – 4000 series	8
◆ Power Splitters – 4000 series	10
◆ Tappers – 6000 series	13
◆ Terminating Loads – 4000 series	14
◆ Attenuators – 4000 series	16

Signal Processing Devices

◆ POI, Combiners and Filter	19
-----------------------------	----

Inter-connecting Components

◆ Feeder Jumper Cable Assembly	27
◆ Feeders	28
◆ Braided Cables	30
◆ Connectors	32
◆ Adaptors and Convertors	33

Antennas

◆ Indoor Antennas – 4000 series	34
◆ Indoor Antennas – 787- series	38
◆ Outdoor Antennas – BTS / Small Cell / Special Antennas	44

Camouflages

◆ Integrated Designs	55
◆ Low Visual Impact Housings	56

Accessories

◆ Installation Tools and Materials	58
------------------------------------	----

Directional Coupler 4000 series

- ❖ Low Insertion Loss
- ❖ Full Range of PIM Values
- ❖ Excellent Input Power Handling
- ❖ Indoor and Outdoor Applications
- ❖ Wall Mount Bracket Included

Directional Coupler 4.3-10 F	D311xx24-v02
Frequency (MHz)	698-4000
Coupling Value (dB)	See below table
VSWR	1.3
PIM3	-160dBc @ 2x43dBm
Input Power	500W
Ingress Protection	IP65
Dimension (mm)	137 x 47.3 x 26

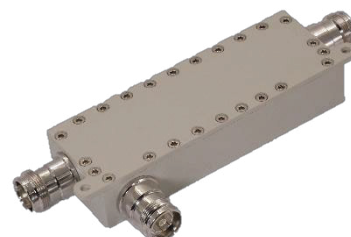

Available Coupling Values (xx represents the coupling value in the type number above).

Coupling Value (xx)	05	06	07	08	10	13	15	20	30
Isolation (dB)	23	24	25	26	28	31	33	38	45

Directional Coupler N F	D313xx14-v02
Frequency (MHz)	698-4000
Coupling Value (dB)	See below table
VSWR	1.3
PIM3	-160dBc @ 2x43dBm
Input Power	300W
Ingress Protection	IP65
Dimension (mm)	137 x 47.3 x 26

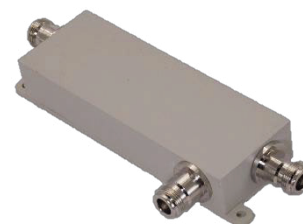

Available Coupling Values (xx represents the coupling value in the type number above).

Coupling Value (xx)	05	06	07	08	10	13	15	20	30
Isolation (dB)	23	24	25	26	28	31	33	38	45

Directional Coupler

4000 series



Directional Coupler DIN 7/16 F	D315xx34-v02
Frequency (MHz)	698-4000
Coupling Value (dB)	See below table
VSWR	1.3
PIM3	-160dBc @ 2x43dBm
Input Power	700W
Ingress Protection	IP65
Dimension (mm)	137 x 47.3 x 26



Available Coupling Values (xx represents the coupling value in the type number above).

Coupling Value (xx)	05	06	07	08	10	13	15	20	30
Isolation (dB)	23	24	25	26	28	31	33	38	45

Also Available:

Frequency range:

698-2700MHz	698-6000MHz	550-4000MHz		
-------------	-------------	-------------	--	--

PIM value:

BLACK series	BLUE series	GREEN series	RED series	Others
-160dBc@2x43dBm	-155dBc@2x43dBm	-150dBc@2x43dBm	-140dBc@2x43dBm	-120dBc@2x43dBm

Hybrid Coupler 4000 series

- ❖ Excellent PIM
- ❖ High Isolation
- ❖ Indoor and Outdoor Applications
- ❖ Wall Mount Bracket Included

Hybrid Coupler 4 x 4	H3112014-V02 4.3-10 Female
	H3132014-V02 N Female
	H3152024-V02 7/16 Female
Frequency (MHz)	698-4000
Isolation (dB)	23
Insertion Loss	6 ±1.2
VSWR	1.25
PIM3	-160dBc @ 2x43dBm
Ingress Protection	IP65
Dimension (mm)	197 x 96.4 x 66



Hybrid Coupler 2 x 2	H3111024-V02 4.3-10 Female
	H3131014-V02 N Female
	H3151034-V02 7/16 Female
Frequency (MHz)	698-4000
Isolation (dB)	25
Insertion Loss	3 ±0.7
VSWR	1.25
PIM3	-160dBc @ 2x43dBm
Ingress Protection	IP65
Dimension (mm)	159 x 43 x 30



Hybrid Coupler 4000 series



Hybrid Coupler 3 x 3	H8314024-V03 4.3-10 Female
	H8334014-V03 N Female
	H8354034-V03 7/16 Female
Frequency (MHz)	698-3800
Isolation (dB)	20
Insertion Loss	4.77 ±1
VSWR	1.3
PIM3	-150dBc @ 2x43dBm
Ingress Protection	IP65
Dimension (mm)	241 x 102 x 40

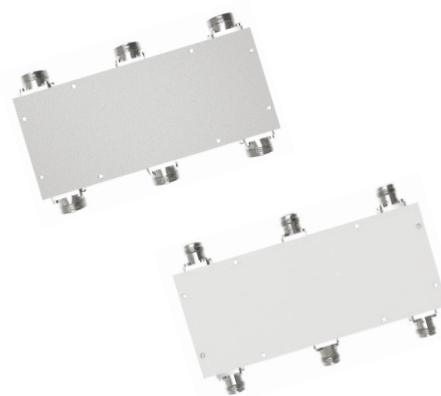

Also Available:

Frequency range:

698-2700MHz	698-6000MHz			
-------------	-------------	--	--	--

PIM value:

BLACK series	BLUE series	GREEN series	RED series	Others
-160dBc@2x43dBm	-155dBc@2x43dBm	-150dBc@2x43dBm	-140dBc@2x43dBm	-120dBc@2x43dBm

Configurations:

2-in / 1-out	1-in / 2-out			
--------------	--------------	--	--	--

Special Isolation:

30dB (pending)				
----------------	--	--	--	--

Power Splitter

4000 series



- ❖ Low Insertion Loss
- ❖ Full Range of PIM Values
- ❖ Excellent Input Power Handling
- ❖ Indoor and Outdoor Applications
- ❖ Wall Mount Bracket Included

Splitter 4.3-10 F (Square Tube)	S3112024-V03 (2-way) S3113024-V03 (3-way) S3114024-V03 (4-way)
Frequency (MHz)	698-4000
Input Power	500W
VSWR	1.3
PIM3	-160dBc @ 2x43dBm
Ingress Protection	IP65
Dimension (mm)	216 x 25 x 25 (2-way) 216 x 25 x 25 (3-way) 243 x 25 x 25 (4-way)



Splitter 4.3-10 F (Round Tube)	S3112024-V02 (2-way) S3113024-V02 (3-way) S3114024-V02 (4-way)
Frequency (MHz)	698-4000
Input Power	500W
VSWR	1.3
PIM3	-160dBc @ 2x43dBm
Ingress Protection	IP65
Dimension (mm)	199 x 25 x 25 (2-way) 233 x 25 x 25 (3-way) 236 x 25 x 25 (4-way)



Power Splitter

4000 series



Splitter N F (Square Tube)	S3132014-V03 (2-way) S3133014-V03 (3-way) S3134014-V03 (4-way)
Frequency (MHz)	698-4000
Input Power	300W
VSWR	1.3
PIM3	-160dBc @ 2x43dBm
Ingress Protection	IP65
Dimension (mm)	216 x 25 x 25 (2-way) 216 x 25 x 25 (3-way) 243 x 25 x 25 (4-way)



Splitter N F (Round Tube)	S3132114-V02 (2-way) S3133114-V02 (3-way) S3134114-V02 (4-way)
Frequency (MHz)	698-4000
Input Power	300W
VSWR	1.3
PIM3	-160dBc @ 2x43dBm
Ingress Protection	IP65
Dimension (mm)	224 x 25 x 25 (2-way) 258 x 25 x 25 (3-way) 288 x 25 x 25 (4-way)



Power Splitter

4000 series

Splitter DIN 7/16 F (Square Tube)	S3152034-V03 (2-way) S3153034-V03 (3-way) S3154034-V03 (4-way)
Frequency (MHz)	698-4000
Input Power	700W
VSWR	1.3
PIM3	-160dBc @ 2x43dBm
Ingress Protection	IP65
Dimension (mm)	216 x 25 x 25 (2-way) 216 x 25 x 25 (3-way) 243 x 25 x 25 (4-way)



Splitter DIN 7/16 F (Round Tube)	S3152134-V02 (2-way) S3153134-V02 (3-way) S3154134-V02 (4-way)
Frequency (MHz)	698-4000
Input Power	700W
VSWR	1.3
PIM3	-160dBc @ 2x43dBm
Ingress Protection	IP65
Dimension (mm)	224 x 25 x 25 (2-way) 258 x 25 x 25 (3-way) 258 x 25 x 25 (4-way)



Also Available:

Frequency range:

698-2700MHz	698-6000MHz	380-4000MHz		
-------------	-------------	-------------	--	--

PIM value:

BLACK series	BLUE series	GREEN series	RED series	Others
-160dBc@2x43dBm	-155dBc@2x43dBm	-150dBc@2x43dBm	-140dBc@2x43dBm	-120dBc@2x43dBm

- ❖ **Excellent PIM**
- ❖ **Full Frequency 380-6000MHz**
- ❖ **Indoor and Outdoor Applications**
- ❖ **Wall Mount Bracket Included**

Tapper	T711xx24-v02 4.3-10 Female
	T713xx14-v02 N Female
	T715xx34-v02 7/16 Female
Frequency (MHz)	380-6000
PIM3	-160dBc @ 2x43dBm
Input Power	300W (N)
	500W (4.3-10)
	700W (7/16)
Ingress Protection	IP65
Dimension (mm)	89 x 25 x 25



Available Tapping Values (xx represents the tapping value in the type number above):

Tapping Value (xx)	05	06	07	08	09	10	13	15	20
Tap Loss (dB)	-1.8 / -4.8	-1.3 / -6.1	-1.0 / -7.0	-0.7 / -8.6	-0.6 / -9.0	-0.4 / -10.4	-0.2 / -13.2	-0.1 / -15.1	-0.1 / -20.1
Split Ratio (dB)	2:1/3	3:1/4.8	4:1/6.0	6:1/8.0	7:1/8.5	10:1/10	20:1/13	30:1/15	100:1/20
Return Loss (dB)	14	15.6	18	18	18	18	18	18	18

Terminating Load 4000 series

- ❖ Full Range of PIM Values
- ❖ Full Range of Power Rating
- ❖ Full Range of Operating Frequency
- ❖ Indoor and Outdoor Applications

Load 50W – 200W	L511xxx4-v03	4.3-10 Female
	L512xxx4-v03	4.3-10 Male
	L513xxx4-v03	N Female
	L514xxx4-v03	N Male
	L515xxx4-v03	7/16 Female
	L516xxx4-v03	7/16 Male
Frequency (MHz)	DC-4000	
VSWR	1.2	
Power Rating (xxx)	050 = 50W 100 = 100W 200 = 200W	
PIM3	-160dBc @ 2x43dBm	
Ingress Protection	IP65	
Dimension (mm)	180 x 150 x 62	



Terminating Load 4000 series



Load 50W – 200W	L551xxx4 4.3-10 Female
	L552xxx4 4.3-10 Male
	L553xxx4 N Female
	L554xxx4 N Male
	L555xxx4 7/16 Female
	L556xxx4 7/16 Male
Frequency (MHz)	DC-4000
VSWR	1.2
Power Rating (xxx)	050 = 50W 100 = 100W 200 = 200W
PIM3	-120dBc @ 2x43dBm
Ingress Protection	IP65
Dimension (mm)	Ø60 x 80 (50W) 160 x 100 x 73 (100W) 200 x 142 x 65 (200W)

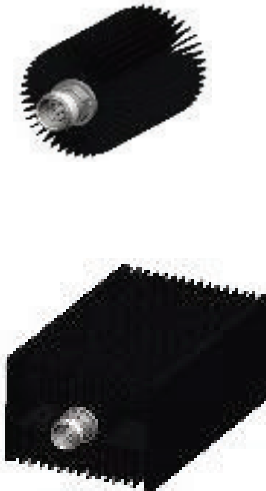

Load 2W – 25W	L571xxx4 4.3-10 Female
	L572xxx4 4.3-10 Male
	L573xxx4 N Female
	L574xxx4 N Male
	L575xxx4 7/16 Female
	L576xxx4 7/16 Male
Frequency (MHz)	DC-4000
VSWR	1.2
Power Rating (xxx)	002 = 2W 005 = 5W 010 = 10W 025 = 25W
PIM3	-120dBc @ 2x33dBm
Ingress Protection	IP65
Dimension (mm)	Ø16 x 30 to Ø20 x 42 (2W & 5W, connector dependent) Ø47 x 39 (10W) Ø60 x 47 (25W)

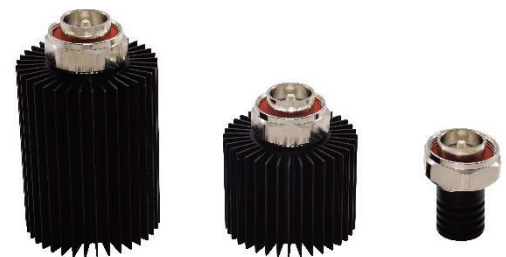

- ❖ Full Range of PIM Values
- ❖ Full Range of Power Rating
- ❖ Full Range of Operating Frequency
- ❖ Indoor and Outdoor Applications

Attenuator 50W	E211xx44-V02	4.3-10 M/F
	E213xx44-V02	N M/F
	E215xx44-V02	7/16 M/F
Frequency (MHz)	698-4000	
VSWR	1.25	
PIM3	-160dBc @ 2x43dBm	
Ingress Protection	IP65	
Dimension (mm)	415 x 290 x 265	

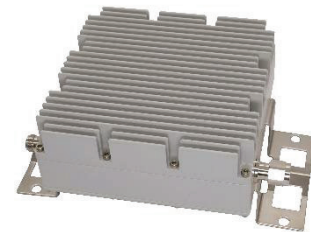

Attenuator 100W	E211xx54-V02	4.3-10 M/F
	E213xx54-V02	N M/F
	E215xx54-V02	7/16 M/F
Frequency (MHz)	698-4000	
VSWR	1.25	
PIM3	-160dBc @ 2x43dBm	
Ingress Protection	IP65	
Dimension (mm)	415 x 290 x 265	

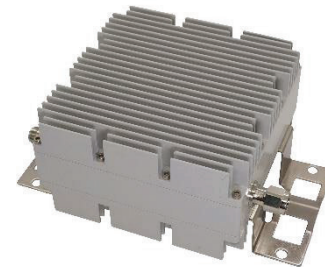

Attenuator 200W	E211xx64-V02	4.3-10 M/F
	E213xx64-V02	N M/F
	E215xx64-V02	7/16 M/F
Frequency (MHz)	698-4000	
VSWR	1.25	
PIM3	-160dBc @ 2x43dBm	
Ingress Protection	IP65	
Dimension (mm)	415 x 365 x 285	



Available Attenuation Values (xx represents the attenuation value in the type number above):

Attenuation Value (xx) (dB)	03	05	06	10	15	20	30	
Attenuation Tolerance (dB)	±0.6	±1.0	±1.0	±1.0	±1.0	±1.3	±1.3	

Important:

The default orientation of attenuators is: input-male and output-female. Device may be damaged if connected in reverse way. Please contact Kantenna sales reps in case of ordering a non-standard configuration.

Attenuator 4000 series



Attenuator 2W	E561xx95-V02 4.3-10 M/F
	E503xx94-V03 N M/F
	E565xx95-V02 7/16 M/F
Attenuator 5W	E561xx15-V02 4.3-10 M/F
	E563xx14-V03 N M/F
	E565xx15-V02 7/16 M/F
Frequency (MHz)	DC-4000
VSWR	1.2
PIM3	-120dBc @ 2x33dBm
Ingress Protection	IP65 (N) IP55 (4.3-10 and 7/16)
Dimension (mm)	Ø18 x 35 (N) Ø30 x 35 (4.3-10) Ø35 x 35 (7/16)

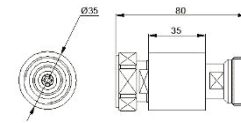
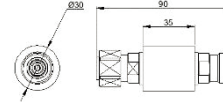

Attenuator 10W	E561xx25-V02 4.3-10 M/F
	E563xx25-V02 N M/F
	E565xx25-V02 7/16 M/F
Frequency (MHz)	DC-4000
VSWR	1.2
PIM3	-120dBc @ 2x33dBm
Ingress Protection	IP55
Dimension (mm)	Ø55 x 69



Important:

The default orientation of attenuators is: input-male and output-female. Device may be damaged if connected in reverse way. Please contact Kantenna sales reps in case of ordering a non-standard configuration.

Attenuator 4000 series

Attenuator 15W	E561xx85-V02 4.3-10 M/F
	E563xx85-V02 N M/F
	E565xx85-V02 7/16 M/F
Attenuator 25W	E561xx35-V02 4.3-10 M/F
	E563xx35-V02 N M/F
	E565xx35-V02 7/16 M/F
Frequency (MHz)	DC-4000
VSWR	1.2
PIM3	-120dBc @ 2x33dBm
Ingress Protection	IP55
Dimension (mm)	Ø60 x 55



Attenuator 50W	E591xx45-V02 4.3-10 M/F
	E593xx45-V02 N M/F
	E595xx45-V02 7/16 M/F
Attenuator 100W	E591xx55-V02 4.3-10 M/F
	E593xx55-V02 N M/F
	E595xx55-V02 7/16 M/F
Frequency (MHz)	DC-4000
VSWR	1.2
PIM3	-105dBc @ 2x43dBm
Ingress Protection	IP55
Dimension (mm)	Ø60 x 85 (50W) / Ø60 x 150 (100W)



Available Attenuation Values (xx represents the attenuation value in the type number above):

Attenuation Value (xx) (dB)	03	05	06	10	15	20	30	
Attenuation Tolerance (dB)	±0.6	±1.0	±1.0	±1.0	±1.0	±1.3	±1.3	

Some attenuation values may not be able for some power ratings. Please consult Kantenna sales reps for details.

Important:

The default orientation of attenuators is: **input-male and output-female**. Device may be damaged if connected in reverse way. Please contact Kantenna sales reps in case of ordering a non-standard configuration.

- ❖ **Excellent PIM**
- ❖ **Outdoor or Indoor Applications**
- ❖ **Good Isolation and Insertion Loss**
- ❖ **Pole Mount or Wall Mount**

Dual Band Combiner N F	G1114002-V02 Single Unit
Frequency Band (MHz)	350-520 / 698-870
PIM3	-150dBc @ 2x43dBm
VSWR	1.3
Isolation	50dB
Power per Port	200W
AISG/DC Bypass	DC Stop at all Ports
Ingress Protection	IP65
Dimension (mm)	190 x 180 x 70



Dual Band Combiner 4.3-10 F	G1213017-V04 Single Unit G1223017-V04 Double Unit
Frequency Band (MHz)	1710-2170 / 2500-2690
PIM3	-155dBc @ 2x43dBm
VSWR	1.25
Isolation	50dB
Power per Port	250W
AISG/DC Bypass	Yes
Ingress Protection	IP67
Dimension (mm)	117 x 116 x 49 (SU) / 117 x 116 x 82 (DU)



Dual Band Combiner 4.3-10 F	G1213016-V04	Single Unit
	G1223016-V04	Double Unit
Frequency Band (MHz)	703-788 / 791-960	
PIM3	-160dBc @ 2x43dBm	
VSWR	1.25	
Isolation	40dB	
Power per Port	200W	
AISG/DC Bypass	Port 2 (791-960)	
Ingress Protection	IP67	
Dimension (mm)	224 x 190 x 62.5 (SU) / 224 x 190 x 130 (DU)	

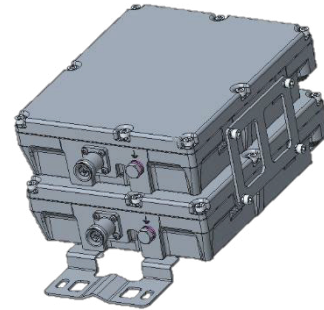

Dual Band Combiner 4.3-10 F*	G1213021-V04	Single Unit
	G1223021-V04	Double Unit
Frequency Band (MHz)	1710-1880 / 1920-2170	
PIM3	-160dBc @ 2x43dBm	
VSWR	1.25	
Isolation	50dB	
Power per Port	250W	
AISG/DC Bypass	Yes	
Ingress Protection	IP67	
Dimension (mm)	148 x 140 x 44 (SU) / 148 x 140 x 92 (DU)	

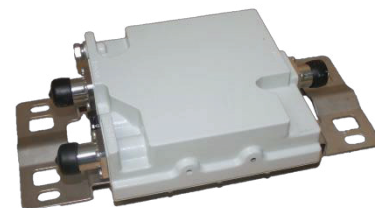

*DIN 7/16 connector versions (G1213022, G1223022) available

Dual Band Combiner 4.3-10 F	G1213025-V04 Single Unit
	G1223025-V04 Double Unit
Frequency Band (MHz)	380-960 / 1710-2700
PIM3	-160dBc @ 2x43dBm
VSWR	1.25
Isolation	50dB
Power per Port	300W
AISG/DC Bypass	Yes
Ingress Protection	IP67
Dimension (mm)	214 x 118 x 46 (SU) / 214 x 118 x 94 (DU)

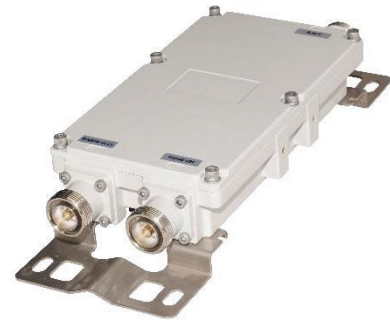

Dual Band Combiner 4.3-10 F	G1215019-V04 Single Unit
	G1225019-V04 Double Unit
Frequency Band (MHz)	1427-1880 / 1920-2690
PIM3	-160dBc @ 2x43dBm
VSWR	1.25
Isolation	50dB
Power per Port	300W
AISG/DC Bypass	Yes
Ingress Protection	IP66
Dimension (mm)	185 x 145 x 56 (SU) / 185 x 145 x 95 (DU)

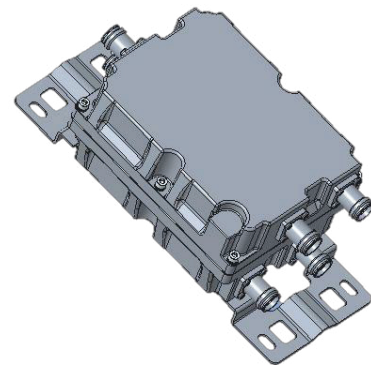

Triple Band Combiner N F	G1311003-V02 Single Unit
Frequency Band (MHz)	380-400 / 400-430 / 440-460
PIM3	-140dBc @ 2x43dBm
VSWR	1.2
Isolation	60dB
Power per Port	200W
AISG/DC Bypass	DC Stop at all Ports
Ingress Protection	Indoor Application Only
Dimension (mm)	242 x 244 x 58

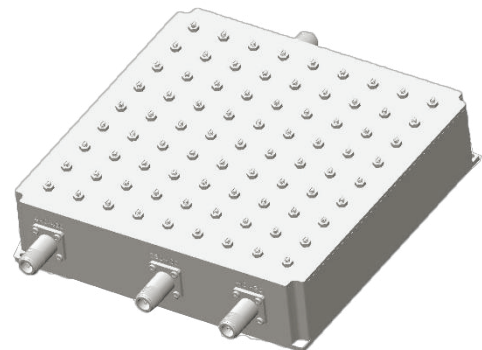

Triple Band Combiner 4.3-10 F*	G1313007-V02 Single Unit
	G1323007-V02 Double Unit
Frequency Band (MHz)	380-960 / 1695-2200 / 2300-2700
PIM3	-150dBc @ 2x43dBm
VSWR	1.2
Isolation	50dB
Power per Port	250W
AISG/DC Bypass	Yes
Ingress Protection	IP67
Dimension (mm)	185 x 173 x 51 (SU) / 185 x 173 x 105 (DU)

*DIN 7/16 connector versions (G1313006, G1323006) available

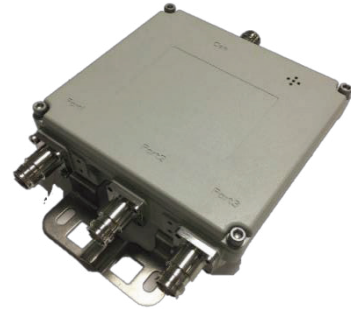

Triple Band Combiner 4.3-10 F*	G1313018-V04 Single Unit
	G1323018-V04 Double Unit
Frequency Band (MHz)	1710-1880 / 1920-2170 / 2300-2690
PIM3	-155dBc @ 2x43dBm
VSWR	1.25
Isolation	50dB
Power per Port	250W
AISG/DC Bypass	Yes
Ingress Protection	IP67
Dimension (mm)	192 x 160 x 55 (SU) / 192 x 160 x 96 (DU)

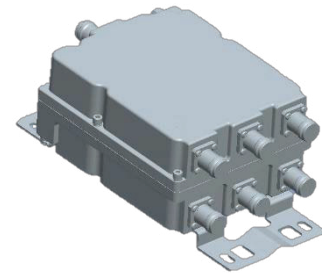

Triple Band Combiner 4.3-10 F*	G1313023-V04 Single Unit
	G1323023-V04 Double Unit
Frequency Band (MHz)	698-960 / 1710-1880 / 1920-2170
PIM3	-160dBc @ 2x43dBm
VSWR	1.25
Isolation	50dB
Power per Port	300W
AISG/DC Bypass	Yes
Ingress Protection	IP67
Dimension (mm)	175 x 175 x 56 (SU) / 175 x 175 x 95 (DU)

*DIN 7/16 connector versions (G1313024, G1323024) available

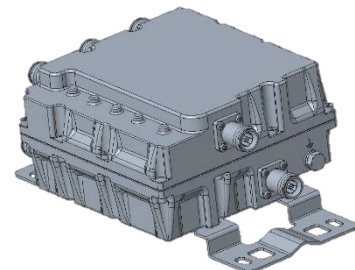

Triple Band Combiner 4.3-10 F	G1315020-V04	Single Unit
	G1325020-V04	Double Unit
Frequency Band (MHz)	380-960 / 1427-1880 / 1920-2690	
PIM3 (@ 2x43dBm)	-150dBc (380-470) / -160dBc (rest)	
VSWR	1.25	
Isolation	50dB	
Power per Port	200W	
AISG/DC Bypass	Yes	
Ingress Protection	IP66	
Dimension (mm)	219 x 175 x 56 (SU) / 219 x 175 x 95 (DU)	

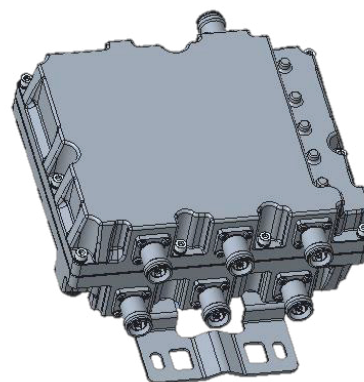

Triple Band Combiner 4.3-10 F	G1315027-V02	Single Unit
	G1325027-V02	Double Unit
Frequency Band (MHz)	708-788 / 791-960 / 1427-3800	
PIM3 (@ 2x43dBm)	-160dBc	
VSWR	1.25	
Isolation	40dB	
Power per Port	200W	
AISG/DC Bypass	Yes	
Ingress Protection	IP66	
Dimension (mm)	260 x 300 x 88 (SU) / 260 x 300 x 181 (DU)	



Penta Band Combiner 4.3-10 F*	G1513015-V02 Single Unit	
	Frequency Band (MHz)	687-960 / 1710-1880 / 1920-2170 2300-2400 / 2500-2690
PIM3	-155dBc @ 2x43dBm	
VSWR	1.2	
Isolation	50dB	
Power per Port	300W	
AISG/DC Bypass	Yes	
Ingress Protection	IP67	
Dimension (mm)	271 x 190 x 58	



*DIN 7/16 connector version (G1513014) available

Duplexer UHF DIN 7/16 F	G2211001-V04 G2211002-V04 Single Unit G2211003-V04
Frequency Band (MHz)	380-385 / 390-395 (G2211001-V04) 382-387 / 392-397 (G2211002-V04) 385-390 / 395-400 (G2211003-V04)
PIM3	-150dBc @ 2x43dBm
VSWR	1.25
Isolation	65dB
Power per Port	200W
AISG/DC Bypass	DC stop at all Ports
Ingress Protection	Indoor Applications Only
Dimension (mm)	265 x 248 x 81



Hybrid Combiner 3:1 N F	G3311004-v02 Single Unit
Frequency Band (MHz)	465-470
PIM3	-105dBc @ 2x43dBm
VSWR	1.25
Isolation	25dB
Power per Port	100W
Ingress Protection	Indoor Applications Only
Dimension (mm)	435 x 155 x 48
Frequency Band (MHz)	465-470

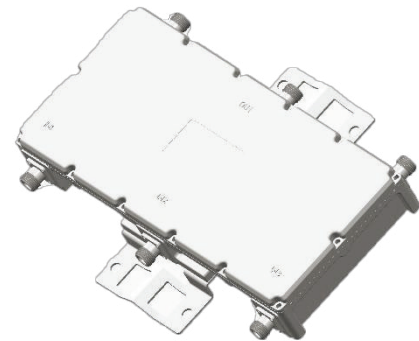

Band Pass Filter 3GHz 4.3-10 F	F1813001-v04 Single Unit
Pass Band (MHz)	3300-3570
PIM3	Not Relevant
VSWR	1.3
Band Rejection	80dB (3610-4200MHz)
Power per Port	200W
No. of Ports	8-in / 8-out
Ingress Protection	IP67
Dimension (mm)	246 x 172 x 60

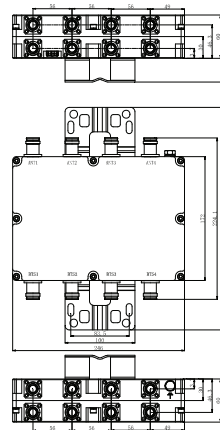

POI 17-in / 4-out DIN 7/16 F	P1741002-v00 Single Unit
Pass Band (MHz)	LTE700 LTE900 LTE1800 WCDMA2100 LTE2600 FDD1 LTE2600 FDD2 LTE2600 FDD3 LTE2600 FDD4 LTE2600 TDD
PIM3	-150dBc @ 2x43dBm
VSWR	1.3
Isolation	110dB (LTE2600) 25dB (same bands) 80dB (different bands)
Power per Port	150W
No. of Ports	21 x DIN 7/16 F (17-in / 4-out)
Ingress Protection	Indoor Applications Only
Dimension (mm)	482 x 417 x 267



POI 6-in / 2-out N F	P0621001-v00 Single Unit
Pass Band (MHz)	DCS1 (1710-1730 / 1805-1825) DCS2 (1730-1750 / 1825-1845) DCS3 (1750-1785 / 1845-1880) WCDMA1 (1920-1935 / 2110-2125) WCDMA2 (1935-1965 / 2125-2155) WCDMA3 (1965-1980 / 2155-2170)
PIM3	-143dBc @ 2x43dBm
VSWR	1.3
Isolation	40dB (intra-band) 80dB (inter-bands)
Power per Port	100W
No. of Ports	8 x N F (6-in / 2-out)
Ingress Protection	Indoor Applications Only
Dimension (mm)	330 x 482 x 132

- ❖ Excellent PIM and VSWR
- ❖ Full Complaint to RoHS
- ❖ PE Over-molded Strain Relief
- ❖ Length from 0.5m to 99.9m

Typical Performance*	
Ingress Protection	IP67
PIM (@2x43dBm)	-160dBc
VSWR	1.15
Mating Cycle	100
Strain Relief	PE overmolded at both ends
Salt Mist Test	96 hours (5% salt concentration)
RoHS Compliance	Full Compliant
UV Resistance	1008 hours according to IEC 62108

*Typical value for reference only. Please check for individual datasheet for details.

**Other cable sizes and types such as RG, LMR are available on request. Please consult Kantenna sales reps for details.

Order Information:

JabcdLLL-Vxx



J	a	b	c and d	LLL
Product Group	Cable Size	Cable Type	Connector Type#	Length of Jumper
Coaxial Jumper	1 = 1/4"	1 = SuperFlex Cable, Normal PE Jacket 2 = SuperFlex Cable, FRPE Jacket 3 = Normal Cable, Normal PE Jacket 4 = Normal Cable, FRPE Jacket	1 = 4.3-10 Female	LLL = XX.X(m)
	2 = 3/8"		2 = 4.3-10 Male	
	3 = 1/2"		3 = N Female	
	4 = 7/8"		4 = N Male	
	5 = 1-1/4"		5 = DIN 7/16 Female	
	6 = 1-5/8"		6 = DIN 7/16 Male	

#Connector style available in "Straight" or "Elbow".

#Other connector types are available on request. Please consult Kantenna sales reps for details.

Ordering Examples:

J3122015-V00: 1/2" Jumper Cable, SuperFlex Cable with PE Jacket, Copper 4.3-10M / 4.3-10M L=1.5m

J3162110-V00: 1/2" Jumper Cable, SuperFlex Cable with PE Jacket, Copper 7/16M / 4.3-10M L=11m

Coaxial Feeder

RF 50ohm Corrugated Tube



- ❖ Excellent PIM and VSWR
- ❖ Full Size Range
- ❖ Normal PE and FRPE Jacket Available
- ❖ Aluminum and Copper Conductor Available

Construction*	Inner Conductor	Insulation	Outer Conductor	Jacket	Cable Diameter
1/4" SuperFlex	Copper Clad Aluminum Wire	Foam PE	Copper Tube	PE or FRPE	7.5mm
1/4" Normal					9.5mm
3/8" SuperFlex					10.4mm
3/8" Normal					11.2mm
1/2" SuperFlex					13.4mm
1/2" Normal					15.7mm
7/8" Normal	Copper Tube				27.5mm
1-1/4" Normal					38.8mm
1-5/8" Normal					49.5mm

*Aluminum conductor available upon request.

Typical Performance*	Cut-off Frequency	PIM (@2x43dBm)	VSWR	Attenuation (dB/100m)	Average Power (kW)
1/4" SuperFlex	20.4GHz	-160dBc	1.15 @4GHz	42.21 @4GHz	0.35 @1GHz
1/4" Normal	19GHz		1.20 @4GHz	36.4 @4GHz	0.52 @1GHz
3/8" SuperFlex	13.4GHz		1.15 @4GHz	32.54 @4GHz	0.57 @1GHz
3/8" Normal	8.2GHz		1.20 @4GHz	25.4 @4GHz	1.04 @1GHz
1/2" SuperFlex	10.2GHz		1.15 @4GHz	25.38 @4GHz	0.89 @1GHz
1/2" Normal	8.8GHz		1.15 @4GHz	15.85 @4GHz	1.04 @1GHz
7/8" Normal	5.2GHz		1.20 @4GHz	9.09 @4GHz	2.19 @1GHz
1-1/4" Normal	3.7GHz		1.20 @3GHz	5.72 @3GHz	3.51 @1GHz
1-5/8" Normal	2.7GHz		1.20 @2.5GHz	4.42 @2.5GHz	4.68 @1GHz
RoHS Compliance	RoHS 2001/65/EU: full compliant China RoHS SJ/T 11364-2006: below maximum concentration value (MCV)				

*Typical value of copper cables for reference only. Please check for individual datasheet for details.

Order Information:

MabcDDDD-Vxx

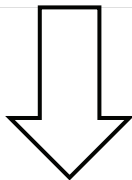

M	a	b	c	DDDD
Product Group	Cable Size	Cable Type	Conductor Type	Control Number
Coaxial Feeder Cable	1 = 1/4"	1 = SuperFlex Cable, Normal PE Jacket 2 = SuperFlex Cable, FRPE Jacket 3 = Normal Cable, Normal PE Jacket 4 = Normal Cable, FRPE Jacket	1 = Copper 2 = Aluminum	Internal Use
	2 = 3/8"			
	3 = 1/2"			
	4 = 7/8"			
	5 = 1-1/4"			
	6 = 1-5/8"			

Ordering Examples:

M3210001-V00: 1/2" Coaxial Feeder Cable, SuperFlex Cable with FRPE Jacket, Copper Conductor

M4310001-V00: 7/8" Coaxial Feeder Cable, Normal Cable with Normal PE Jacket, Copper Conductor

Coaxial Feeder

RF 50ohm Braided Cable KNC series



- ❖ **Standard Alternative to Industrial LMR Cables**
- ❖ **Full Size Range (0.195" to 0.900")**
- ❖ **High Double Shielding Effect by Braided Copper Wire and Aluminum Tape**
- ❖ **Normal PE and FRPE Jacket Available**

Cable Type**	KNC-195 KNC-195R	KNC-200 KNC-200R	KNC-240 KNC-240R	KNC-300 KNC-300R	KNC-400 KNC-400R	KNC-500 KNC-500R	KNC-600 KNC-600R	KNC-900 KNC-900R	
Inner Conductor*	Ø 0.94mm Copper Wire	Ø 1.12mm Copper Wire	Ø 1.42mm Copper Wire	Ø 1.78mm Copper Wire	Ø 2.74mm CCA Wire	Ø 3.61mm CCA Wire	Ø 4.47mm CCA Wire	Ø 6.65mm Copper Tube	
DC Resistance	24.93 ohm/km	24.93 ohm/km	11.1 ohm/km	6.95 ohm/km	4.69 ohm/km	2.69 ohm/km	1.74 ohm/km	1.77 ohm/km	
Dielectric Type / Size	Ø 2.79mm Foam PE	Ø 2.95mm Foam PE	Ø 3.81mm Foam PE	Ø 4.83mm Foam PE	Ø 7.24mm Foam PE	Ø 9.40mm Foam PE	Ø 11.56mm Foam PE	Ø 17.27mm Foam PE	
Shielding Construction	Tinned Copper Wire Braiding, 90% Coverage Aluminum Tape								
Outer Cond. Dia.	Ø 2.95mm	Ø 2.95mm	Ø 4.52mm	Ø 4.98mm	Ø 8.08mm	Ø 9.55mm	Ø 12.50mm	Ø 17.42mm	
DC Resistance	16.07 ohm/km	16.07 ohm/km	12.76 ohm/km	8.5 ohm/km	5.61 ohm/km	4.16 ohm/km	5.75 ohm/km	1.8 ohm/km	
Jacket Material	PE FRPE								
Cable Diameter	Ø 4.95mm	Ø 4.95mm	Ø 6.10mm	Ø 7.62mm	Ø 10.29mm	Ø 12.705mm	Ø 14.99mm	Ø 22.10mm	
Normal Size	0.195"	0.195"	0.240"	0.300"	0.400"	0.500"	0.600"	0.900"	
Peak Power	2.5kW	2.5kW	5.6kW	10kW	16kW	22kW	40kW	62kW	
Capacitance	79.7pF/m	79.7pF/m	79.8pF/m	79.1pF/m	78pF/m	77.5pF/m	76pF/m	76pF/m	
Max Frequency	41GHz	41GHz	31GHz	24.5GHz	16.2GHz	10.3GHz	10.2GHz	7GHz	
Operating Frequency	30-6000MHz							30-5800MHz	

*CCA Wire = Copper Cladded Aluminum Wire

**Cable types shown above refer to standard design. Other designs are available upon request. Please contact Kantenna Sales Reps for details.

***Values are typical

General Regulatory Compliance

RoHS 2011/65/EU	Compliant
China RoHS SJ/T 11364-2014	Below Maximum Concentration Value (MCV)

Coaxial Feeder RF 50ohm Braided Cable KNC series



Ordering Information:

Industrial Reference	Kantenna Cable Type	Kantenna Type No.
LMR-195 PE	KNC-195	M9000010-V00
LMR-195 FRPE	KNC-195R	M9000011-V00
LMR-200 PE	KNC-200	M9000020-V00
LMR-200 FRPE	KNC-200R	M9000021-V00
LMR-240 PE	KNC-240	M9000030-V00
LMR-240 FRPE	KNC-240R	M9000031-V00
LMR-300 PE	KNC-300	M9000040-V00
LMR-300 FRPE	KNC-300R	M9000041-V00
LMR-400 PE	KNC-400	M9000050-V00
LMR-400 FRPE	KNC-400R	M9000051-V00
LMR-500 PE	KNC-500	M9000060-V00
LMR-500 FRPE	KNC-500R	M9000061-V00
LMR-600 PE	KNC-600	M9000070-V00
LMR-600 FRPE	KNC-600R	M9000071-V00
LMR-900 PE	KNC-900	M9000080-V00
LMR-900 FRPE	KNC-900R	M9000081-V00

- ❖ Excellent PIM and VSWR
- ❖ Converting Existing Connectors
- ❖ Straight and Elbow Style Available

Typical Performance*	Interface Standard	Ingress Protection	PIM (@2x43dBm)	VSWR	Mating Cycles
DIN 7/16 Connector	IEC60169-4	IP67	-155dBc	1.15	500
N Connector	IEC60169-16	IP67	-155dBc	1.15	500
4.3-10 Connector	IEC61169-54	IP67	-155dBc	1.15	500
Salt Mist Test	48 hours (5% salt concentration)				
RoHS Compliance	Full Compliant				

Order Information:

C1abcdXX-Vxx



C1	a	b	c	d	XX
Product Group	Connector Type**	Connector Gender and Style**	For Cable Size***	For Cable Type***	Control Number
Connector	1 = 4.3-10 2 = N 3 = DIN 7/16	1 = Male Straight 2 = Male Angle 3 = Female Straight 4 = Female Angle	1 = 1/2" 2 = 7/8" 3 = 1-1/4" 4 = 1-5/8"	1 = SF + FRPE 2 = SF 3 = Normal + FRPE 4 = Normal	Internal Use

Ordering Examples:

- C1211400-V00:** N Male Straight Connector for 1/2" Normal Cable
C1121400-V00: 4.3-10 Male Angle Connector for 1/2" Normal Cable
C1332400-V00: 7/16 Female Straight Connector for 7/8" Normal Cable

*Typical value for reference only. Please refer to individual datasheet for details.
 **Other connector types are available on request. Please consult Kantenna sales reps for details.
 ***Other cable types are available on request. Please consult Kantenna sales reps for details.

- ❖ Excellent PIM and VSWR
- ❖ Converting Existing Connectors
- ❖ Straight and Elbow Style Available

Typical Performance*	Interface Standard	Ingress Protection	PIM (@2x43dBm)	VSWR	Mating Cycles
DIN 7/16 Connector	IEC60169-4	IP67	-155dBc	1.15	500
N Connector	IEC60169-16	IP67	-155dBc	1.15	500
4.3-10 Connector	IEC61169-54	IP67	-155dBc	1.15	500
Salt Mist Test	48 hours (5% salt concentration)				
RoHS Compliance	Full Compliant				

Order Information:

C3abcXXX-Vxx



C3	a	b	c	XXX
Product Group	Connector 1 Type**	Connector 2 Type**	Connector Gender and Style	Control Number
Adaptor / Converter	1 = 4.3-10 2 = N 3 = DIN 7/16	1 = 4.3-10 2 = N 3 = DIN 7/16	1 = Male / Male – Straight 2 = Male / Female – Straight 3 = Female / Male – Straight 4 = Female / Female – Straight 5 = Male / Male – Elbow 6 = Male / Female – Elbow 7 = Female / Male – Elbow 8 = Female / Female – Elbow	Internal Use

Ordering Examples:

C3132000-V00: 4.3-10 Male – 7/16 Female Straight Converter
C3337000-V00: 7/16 Female – 7/16 Male Elbow Converter

*Typical value for reference only. Please refer to individual datasheet for details.

**Other connector types are available on request. Please consult Kantenna sales reps for details.

Indoor Antenna

4000 series



- ❖ Excellent PIM
- ❖ 698-4000, including L-band
- ❖ Pigtail Connection for Easy Installation
- ❖ Wall Mount / Ceiling Mount

Omni Dome 1-port	A1113110-V00	4.3-10 Female
	A1133110-V00	N Female
Frequency (MHz)	698-960 / 1425-4000	
Gain (dBi)	2.0 / 4.0	
VSWR	2.0 / 1.5	
PIM3	-153dBc @ 2x43dBm	
Dimension (mm)	Ø204 x 125	



Omni Mini Dome 1-port	A2113110-V00	4.3-10 Female
	A2133110-V00	N Female
Frequency (MHz)	698-960 / 1425-4000	
Gain (dBi)	2.0 / 5.5	
VSWR	2.0 / 1.5	
PIM3	-153dBc @ 2x43dBm	
Dimension (mm)	Ø186 x 86	



Omni Slim 1-port	A3113110-V00	4.3-10 Female
	A3113111-V00	4.3-10 Female
	A3133110-V00	N Female
	A3133111-V00	N Female
Frequency (MHz)	698-960 / 1425-4000	
Gain (dBi)	3.5 / 5.0	
VSWR	2.0 / 1.8	
PIM3	-153dBc @ 2x43dBm	
Dimension (mm)	Ø215 x 47	



Indoor Antenna

4000 series



Omni Thin Plate 1-port (Rect.)	A4113120-v00	4.3-10 Female
	A4133120-v00	N Female
Frequency (MHz)	698-960 / 1425-4000	
Gain (dBi)	3.0 / 5.0	
VSWR	2.0 / 1.8	
PIM3	-153dBc @ 2x43dBm	
Dimension (mm)	180 x 110 x 7	



Omni Thin Plate 1-port (Round)	A6113120-v00	4.3-10 Female
	A6133120-v00	N Female
Frequency (MHz)	698-960 / 1425-4000	
Gain (dBi)	2.5 / 5.0	
VSWR	2.0 / 1.8	
PIM3	-153dBc @ 2x43dBm	
Dimension (mm)	Ø190 x 7.3	



Panel 1-port	A5113110-v00	4.3-10 Female
	A5133110-v00	N Female
Frequency (MHz)	698-960 / 1425-4000	
Gain (dBi)	6.5 / 8.0	
VSWR	2.0 / 1.8	
PIM3	-153dBc @ 2x43dBm	
Dimension (mm)	180 x 158 x 60	



Omni Dome 1-port (Wide Band)	A2117110-v00	4.3-10 Female
	A2137110-v00	N Female
Frequency (MHz)	380-520 / 600-960 / 1425-6000	
Gain (dBi)	1.5 / 2.5 / 5.5	
VSWR	2.5 / 2.0 / 2.0	
PIM3	-153dBc @ 2x43dBm	
Dimension (mm)	Ø285 x 135	



Indoor Antenna 4000 series



Omni Slim 2-port	A3213130-V00 4.3-10 Female
	A3213131-V00 4.3-10 Female
	A3233130-V00 N Female
	A3233131-V00 N Female
Frequency (MHz)	698-960 / 1425-4000
Gain (dBi)	2.5 / 5.0
VSWR	2.0 / 1.8
PIM3	-153dBc @ 2x43dBm
Isolation	19 / 23
Dimension (mm)	Ø215 x 47



Omni Thin Plate 2-port (Rect.)	A4213160-V00 4.3-10 Female
	A4233160-V00 N Female
Frequency (MHz)	698-960 / 1425-4000
Gain (dBi)	3.0 / 6.0
VSWR	2.0 / 1.8
PIM3	-153dBc @ 2x43dBm
Isolation	20 / 23
Dimension (mm)	250 x 150 x 12



Omni Thin Plate 2-port (Round)	A6213160-V00 4.3-10 Female
	A6233160-V00 N Female
Frequency (MHz)	698-960 / 1425-4000
Gain (dBi)	3.0 / 6.0
VSWR	2.0 / 1.8
PIM3	-153dBc @ 2x43dBm
Isolation	20 / 23
Dimension (mm)	Ø280 x 19



Indoor Antenna

4000 series



Panel 2-port	A5213130-v00	4.3-10 Female
	A5233130-v00	N Female
Frequency (MHz)	698-960 / 1425-4000	
Gain (dBi)	2.0 / 4.0	
VSWR	1.8 / 1.5	
PIM3	-153dBc @ 2x43dBm	
Isolation	12 / 24	
Dimension (mm)	315 x 195 x 68	



Omni Slim 4-port (Round)	A2413160-v00	4.3-10 Female
	A2433160-v00	N Female
Frequency (MHz)	698-960 / 1425-4000	
Gain (dBi)	3.5 / 4.5	
VSWR	2.0 / 2.0	
PIM3	-153dBc @ 2x43dBm	
Isolation	15 / 20	
Dimension (mm)	Ø350 x 45	

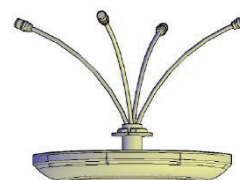

Panel 4-port	A5413130-v00	4.3-10 Female
	A5433130-v00	N Female
Frequency (MHz)	698-960 / 1425-4000	
Gain (dBi)	5.5 / 8.0	
VSWR	2.0 / 2.0	
PIM3	-153dBc @ 2x43dBm	
Isolation	12 / 24	
Dimension (mm)	385 x 315 x 68	



Also Available:

Frequency range (with or without L-band):

698-2700MHz	698-6000MHz	380-6000MHz		
-------------	-------------	-------------	--	--

PIM value:

BLACK series	BLUE series	GREEN series	RED series	Others
-153dBc@2x43dBm	-150dBc@2x43dBm	-140dBc@2x43dBm		-150dBc@2x33dBm -140dBc@2x33dBm

Indoor Antenna

787- series



- ❖ Identical to 787 series – direct replaced by KANTENNA type
- ❖ Alternative to 800 series – similar type with same or better performance

Omni Mini Dome 1-port	A2112210-V00	78712019 (4.3-10 F)
	A2132210-V00	78711019 (N F)
Frequency (MHz)	698-960 / 1710-2700	
Gain (dBi)	2.0 / 5.0	
VSWR	1.8 / 1.5	
PIM3	-150dBc @ 2x43dBm	
Dimension (mm)	Ø186 x 86	



Omni Dome 1-port	A1113110-V00	78712031 (4.3-10 F)
Frequency (MHz)	698-960 / 1425-4000	
Gain (dBi)	1.5 / 4.0	
VSWR	2.0 / 1.5	
PIM3	-153dBc @ 2x43dBm	
Dimension (mm)	Ø204 x 125	



Omni Thin Plate 1-port (Rect.)	A4113120-V00	78712033 (4.3-10 F)
Frequency (MHz)	698-960 / 1425-4000	
Gain (dBi)	3.0 / 5.0	
VSWR	2.0 / 1.5	
PIM3	-153dBc @ 2x43dBm	
Dimension (mm)	180 x 110 x 7	



Indoor Antenna

787- series



Omni Thin Plate 1-port (Round)	A6113120-V00	78712035 (4.3-10 F)
Frequency (MHz)	698-960 / 1425-4000	
Gain (dBi)	2.5 / 5.0	
VSWR	2.0 / 1.8	
PIM3	-153dBc @ 2x43dBm	
Dimension (mm)	Ø190 x 7.3	



Omni Dome 1-port (Wide Band)	A2117110-V00	78712041 (4.3-10 F)
Frequency (MHz)	380-520 / 600-960 / 1425-6000	
Gain (dBi)	1.5 / 2.5 / 5.5	
VSWR	2.5 / 2.0 / 2.0	
PIM3	-153dBc @ 2x43dBm	
Dimension (mm)	Ø285 x 135	



Omni Small Cell 1-port 4.3-10F	B1312008-V00	78712043 (Cubical)
	B1312009-V00	78712045 (Cylindrical)
Frequency (MHz)	698-960 / 1425-4000	
Gain (dBi)	3.0 / 4.5	
VSWR	1.8	
PIM3	-150dBc @ 2x43dBm	
Dimension (mm)	66 x 66 x 190 / Ø63 x 190	



Panel 1-port	A5112210-V00	78712313 (4.3-10 F)
	A5132210-V00	78711313 (N F)
Frequency (MHz)	698-960 / 1690-2700	
Gain (dBi)	6.5 / 9.0	
VSWR	1.8 / 1.5	
PIM3	-150dBc @ 2x43dBm	
Dimension (mm)	168 x 158 x 50	



Indoor Antenna

787- series



Omni Slim 2-port	A3213130-V00	78712030 (4.3-10 F)
	A3213131-V00	78712030V01 (4.3-10 F)
	A3233130-V00	78711030 (N F)
	A3233131-V00	78711030V01 (N F)
Frequency (MHz)	698-960 / 1425-4000	
Gain (dBi)	2.5 / 5.0	
VSWR	2.0 / 1.8	
PIM3	-153dBc @ 2x43dBm	
Isolation	19 / 23	
Dimension (mm)	Ø215 x 47	

A3213131-V00
A3233131-V00



A3213130-V00
A3233130-V00

Omni Dome 2-port	A1212231-V00	78712014 (4.3-10 F)
	A1232231-V00	78711014 (N F)
Frequency (MHz)	698-960 (SISO) / 1710-2700 (MIMO)	
Gain (dBi)	2.0 / 4.0	
VSWR	1.8 / 1.8	
PIM3	-150dBc @ 2x43dBm	
Isolation	25	
Dimension (mm)	Ø182 x 123	



Omni Slim 2-port	A3212230-V00	78712020 (4.3-10 F)
	A3232230-V00	78711020 (N F)
Frequency (MHz)	698-960 / 1710-2700	
Gain (dBi)	3.0 / 4.5	
VSWR	1.8 / 1.7	
PIM3	-150dBc @ 2x43dBm	
Isolation	19 / 23	
Dimension (mm)	Ø215 x 47	



Indoor Antenna

787- series



Panel 2-port	A5212250-V00	78712311 (4.3-10 F)
	A5232250-V00	78711311 (N F)
Frequency (MHz)	698-960 / 1690-2700	
Gain (dBi)	6.5 / 9.0	
VSWR	1.8 / 1.7	
PIM3	-150dBc @ 2x43dBm	
Isolation	20 / 23	
Dimension (mm)	315 x 195 x 68	



Panel 2-port	A5213130-V00	78712330 (4.3-10 F)
Frequency (MHz)	698-960 / 1425-4000	
Gain (dBi)	5.5 / 8.5	
VSWR	2.0 / 2.0	
PIM3	-153dBc @ 2x43dBm	
Isolation	12 / 24	
Dimension (mm)	315 x 195 x 68	



Omni Thin Plate 2-port (Rect.)	A4213260-V00	78712032 (4.3-10 F)
Frequency (MHz)	698-960 / 1425-4000	
Gain (dBi)	3.0 / 6.0	
VSWR	2.0 / 1.8	
PIM3	-150dBc @ 2x43dBm	
Isolation	20 / 23	
Dimension (mm)	250 x 150 x 12	



Indoor Antenna

787- series



Omni Thin Plate 2-port (Round)	A6213260-v00	78712034 (4.3-10 F)
Frequency (MHz)	698-960 / 1425-4000	
Gain (dBi)	3.0 / 6.0	
VSWR	2.0 / 1.8	
PIM3	-150dBc @ 2x43dBm	
Isolation	20 / 23	
Dimension (mm)	Ø280 x 19	



Omni Mini Dome 1-port	A2115210-v00	80020249 (4.3-10 F)
	A2135210-v00	80010249 (N F)
Frequency (MHz)	698-960 / 1425-6000	
Gain (dBi)	2.0 / 5.5	
VSWR	2.0 / 1.8	
PIM3	-150dBc @ 2x43dBm	
Dimension (mm)	Ø186 x 86	



Omni Dome 1-port	A1115210-v00	80020249 (4.3-10 F)
	A1135210-v00	80010249 (N F)
Frequency (MHz)	698-960 / 1425-6000	
Gain (dBi)	1.5 / 4.5	
VSWR	2.0 / 2.0	
PIM3	-150dBc @ 2x43dBm	
Dimension (mm)	Ø204 x 125	



Other Suggestions for 800-series:

800 series	Suggested Substitutions
80010465	78711313 / A5132210
80010677	78711311 / A5232250
80010710	78711020 / A3232230
80010748	78711019 / A2132210
80010882	78712311 / A5212250
80020710	78712030V01 / A3213131
80020249	A1115210 or A2115210
80010249	A1135210 or A2135210

- ❖ **Excellent PIM**
- ❖ **Outdoor Applications**
- ❖ **Pole Mount Bracket Included**

Omni 698-4000 1-port V-pol	B1311008-V00 4.3-10 F B1331008-V00 N F
Frequency (MHz)	698-960 / 1425-2700 / 3300-4000
PIM3	-153dBc @ 2x43dBm
VSWR	1.8
Gain	3dBi / 4dBi / 4.5dBi
Polarization	V
Beam Width	H: 360° / V: 80°/52°/38°
Dimension (mm)	66 x 66 x 190



Omni 698-4000 1-port V-pol	B1311009-V00 4.3-10 F B1331009-V00 N F
Frequency (MHz)	698-960 / 1425-2700 / 3300-4000
PIM3	-153dBc @ 2x43dBm
VSWR	1.8
Gain	3dBi / 4dBi / 4.5dBi
Polarization	V
Beam Width	H: 360° / V: 80°/52°/38°
Dimension (mm)	Ø63 x 190



Omni 698-4000 1-port V-pol	B1411010-v00 4.3-10 F
	B1431010-v00 N F
Frequency (MHz)	698-960 / 1710-2700 / 3300-4000
PIM3	-153dBc @ 2x43dBm
VSWR	2.5 / 3.0 / 1.5
Gain	3dBi / 3.2dBi / 2.7dBi
Polarization	V
Beam Width	H: 360° / V: 85°/50°/33°
Dimension (mm)	Ø30 x 200



Omni 698-6000 1-port V-pol	B1611010-v00 4.3-10 F
	B1631010-v00 N F
Frequency (MHz)	698-960 / 1710-2700 / 3300-4000 / 4900-6000
PIM3	-153dBc @ 2x43dBm
VSWR	2.5 / 3.0 / 1.5 / 2.0
Gain	3dBi / 3.2dBi / 2.7dBi / 2.6dBi
Polarization	V
Beam Width	H: 360° / V: 85°/50°/33°/30°
Dimension (mm)	Ø30 x 200



Log-Periodic 900/2700 1-port V-pol	B2212001-v00 4.3-10 F
	B2232001-v00 N F
Frequency (MHz)	698-960 / 1710-2700
PIM3	-150dBc @ 2x43dBm
VSWR	1.8 / 1.5
Gain	10dBi / 11dBi
F/B Ratio	15dB
Polarization	V
Beam Width	H: 75°/73° / V: 65°/52°
Dimension (mm)	440 x 205 x 60



Log-Periodic 900/4000 1-port V-pol	B2412008-v00 4.3-10 F B2432008-v00 N F
Frequency (MHz)	698-960 / 1710-2700 / 3300-4000
PIM3	-150dBc @ 2x43dBm
VSWR	2.0 / 1.5 / 1.8
Gain	8dBi / 9dBi / 9.5dBi
F/B Ratio	15dB
Polarization	V
Beam Width	H: 95°/78°/59° / V: 68°/56°/48°
Dimension (mm)	249 x 210 x 65



Log-Periodic 900/4000 1-port V-pol	B2412009-v00 4.3-10 F B2432009-v00 N F
Frequency (MHz)	698-960 / 1710-2700 / 3300-4000
PIM3	-150dBc @ 2x43dBm
VSWR	2.0 / 1.5 / 1.8
Gain	9.5dBi / 11dBi / 11.5dBi
F/B Ratio	15dB
Polarization	V
Beam Width	H: 90°/75°/54° / V: 66°/58°/42°
Dimension (mm)	440 x 205 x 60



Omni 900 1-port V-pol	B1012011-v00 4.3-10 F
Frequency (MHz)	698-960
PIM3	-150dBc @ 2x43dBm
VSWR	1.5
Gain	10.5dBi
E-tilt	4° D/T, Pre-fixed
Polarization	V
Beam Width	H: 360° / V: 7.5°
Dimension (mm)	Ø52 x 3000



Omni 900 2-port VV-pol	B1012013-v00 4.3-10 F
Frequency (MHz)	698-960
PIM3	-150dBc @ 2x43dBm
VSWR	1.7
Gain	2 x 7.5dBi
E-tilt	2° D/T, Pre-fixed
Polarization	V-V
Beam Width	H: 360° / V: 15°
Dimension (mm)	Ø76 x 3200



Quasi Omni 900 2-port X-pol	B1012012-v00 4.3-10 F
Frequency (MHz)	698-960
PIM3	-150dBc @ 2x43dBm
VSWR	1.7
Gain	10.5dBi
E-tilt	6° D/T, Pre-fixed
Polarization	X
Isolation	18dB
Beam Width	H: 360° / V: 7°
Dimension (mm)	Ø280 x 2300



Quasi Omni 900/2700 4-port XX-pol	B1012014-v00 4.3-10 F
Frequency (MHz)	698-960 / 1710-2700
PIM3	-150dBc @ 2x43dBm
VSWR	1.7
Gain	8dBi / 12dBi
Polarization	XX
Beam Width	H: 360° / V: 12°/7°
Dimension (mm)	Ø280 x 2300



Omni UHF 1-port	B1052003-v00 DIN 7/16 F
Frequency (MHz)	380-400
PIM3	-150dBc @ 2x43dBm
VSWR	1.5
Gain	8dBi
E-tilt	5° D/T, Pre-fixed
Polarization	V
Beam Width	H: 360° / V: 14°
Dimension (mm)	Ø52 x 3600



Panel 900/2700 2-port X-pol	B3211007-v00 4.3-10 F B3251008-v00 DIN 7/16 F
Frequency (MHz)	698-960 / 1710-2700
PIM3	-153dBc @ 2x43dBm
VSWR	1.6 / 1.8
Gain	8dBi / 9dBi
E-tilt	0° D/T, Pre-fixed
Isolation	20dB / 25dB
F/B Ratio	20dB / 23dB
Polarization	X
Beam Width	H: 65°/65° / V: 70°/65°
Dimension (mm)	350 x 280 x 130



Panel 900/2700 2-port X-pol	B3212005-v00 4.3-10 F B3252006-v00 DIN 7/16 F
Frequency (MHz)	698-960 / 1710-2700
PIM3	-150dBc @ 2x43dBm
VSWR	1.6 / 1.8
Gain	8dBi / 9dBi
E-tilt	0° D/T, Pre-fixed
Isolation	20dB / 25dB
F/B Ratio	20dB / 23dB
Polarization	X
Beam Width	H: 65°/65° / V: 70°/65°
Dimension (mm)	350 x 280 x 130



Panel 900/2700 1-port V-pol Narrow Beam	B3012010-v00 4.3-10 F B3032010-v00 N F
Frequency (MHz)	698-960 / 1710-2700
PIM3	-150dBc @ 2x43dBm
VSWR	1.5 / 1.7
Gain	12dBi / 15dBi
E-tilt	0° D/T, Pre-fixed
F/B Ratio	15dB / 20dB
Polarization	V
Beam Width	H: 35°/30° / V: 35°/30°
Dimension (mm)	450 x 450 x 115

Panel 1710/2700 2-port X-pol	B3015002-v00 4.3-10 F B3055002-v00 DIN 7/16 F
Frequency (MHz)	1710-2700
PIM3	-150dBc @ 2x43dBm
VSWR	1.5
Gain	12dBi
E-tilt	0° D/T, Pre-fixed
Isolation	25dB
F/B Ratio	25dB
Polarization	X
Beam Width	H: 65° / V: 35°
Dimension (mm)	260 x 160 x 80



Log-Periodic 900/2700/4000 1-port V-pol	B2412010-v00 4.3-10 F B2452010-v00 DIN 7/16 F
Frequency (MHz)	698-960 / 1710-2700 / 3300-4000
PIM3	-150dBc @ 2x43dBm
VSWR	1.5 / 1.5 / 1.5
Gain	12.5dBi / 13.5dBi / 13.5dBi
F/B Ratio	25dB / 25dB / 23dB
Polarization	V
Beam Width	H: 56°/45°/40° / V: 47°/37°/32°
Dimension (mm)	250 x 200 x 1040

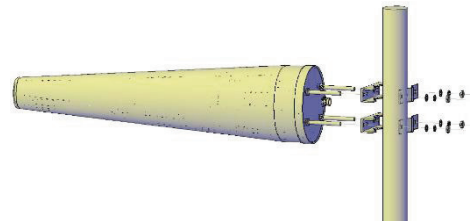

Log-Periodic 900/2700 1-port V-pol	B2112011-v00 4.3-10 F B2152011-v00 DIN 7/16 F
Frequency (MHz)	698-960 / 1695-2690
PIM3	-150dBc @ 2x43dBm
VSWR	1.5
Gain	10.3dBi / 11dBi
F/B Ratio	20dB / 25dB
Polarization	V
Beam Width	H: 67°/47° / V: 54°/45°
Dimension (mm)	300 x 155 x 785

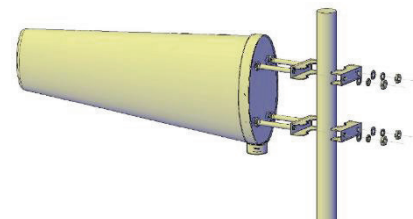

Log-Periodic 900/2700 2-port V/H-pol	B2112012-v00 4.3-10 F B2152012-v00 DIN 7/16 F
Frequency (MHz)	698-960 / 1695-2690
PIM3	-150dBc @ 2x43dBm
VSWR	1.8 / 1.6
Gain	9.5dBi / 11dBi
F/B Ratio	20dB / 25dB
Isolation	20dB / 28dB
Polarization	V/H
Beam Width	H: 68°/58° / V: 53°/45°
Dimension (mm)	300 x 300 x 785

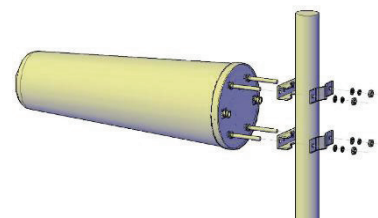

Log-Periodic 3300-3800 4-port XX-pol	B2011014-v00 4.3-10 F
	B2031014-v00 N F
Frequency (MHz)	3300-3800
PIM3	-153dBc @ 2x43dBm
VSWR	1.5
Gain	12
F/B Ratio	20dB
Polarization	±45°
Beam Width	H: 55° / V: 48°
Dimension (mm)	Ø186 x 185

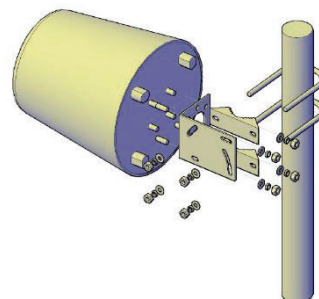

Panel Tetra 380-450 / 450-500 2-port X-pol	B3052015-v01 DIN 7/16F
Frequency (MHz)	380-450 / 450-500
PIM3	-150dBc @ 2x43dBm
VSWR	1.5
Gain	14dBi / 14.5dBi
F/B Ratio	25dB
Isolation	28dB
Polarization	±45°
E-Tilt	3° Fixed
Beam Width	H: 72°/68° / V: 19°/17°
Dimension (mm)	2050 x 450 x 145



Panel Tetra 380-450 / 450-500 2-port X-pol	B3052016-v01 DIN 7/16F
Frequency (MHz)	380-450 / 450-500
PIM3	-150dBc @ 2x43dBm
VSWR	1.5
Gain	13.5dBi / 14dBi
F/B Ratio	25dB
Isolation	25dB
Polarization	±45°
E-Tilt	0° - 14° (Internal RET)
Beam Width	H: 70°/67° / V: 20°/18°
Dimension (mm)	2050 x 450 x 145



Panel Tetra 380-450 / 450-500 2-port X-pol	B3052017-v01 DIN 7/16F
Frequency (MHz)	380-450 / 450-500
PIM3	-150dBc @ 2x43dBm
VSWR	1.5
Gain	13.5dBi / 14dBi
F/B Ratio	25dB
Isolation	25dB
Polarization	±45°
E-Tilt	0° - 14° (by Hand or Optional External RET)
Beam Width	H: 70°/67° / V: 20°/18°
Dimension (mm)	2050 x 450 x 145



CAMOUFLAGE SITE SOLUTIONS

In times of almost unlimited need for mobile access anytime and anywhere, the deployment of mobile cell sites in high density areas is a universal approach. But most of the inner-city areas which are at their capacity limits with high visual impact. The aesthetic integration of the street equipment to be antenna sites has become a major challenge.

KANTENNA Camouflage Antenna Solutions introduce innovative approaches to provide low visual impact, high quality camouflage antenna site solution for smart campuses and smart cities connectivity applications, which are designed for easy installation and to become part of the smart campuses and smart cities environment such as lamp poles, trees, lawn lamps, billboards, columns and spotlights, bins, chimneys, etc.

On top of camouflage designs, KANTENNA also provides camouflages that has integrated certain real appliance functions to replace existing appliance without being noticed that a RF device has been hidden. This approach provides a direct replacement of existing appliance without the need of additional space.

We accept requests for customized designs to suit environments and customs in different territories and scenarios.



- ❖ Real functional devices with integrated RF antenna
- ❖ Direct replacement of existing device with add-on RF functions

Integrated Omni Antenna LED Panel Ceiling Mount

Antenna Type	Omni
Frequency (MHz)	698-2700 / 698-4000 / 698-6000
No of Ports	1 / 2 / 4
Connector	N or 4.3-10
Dimension (mm)	600 x 600
Lumen Output (lm)	2100-2300
Colour Temp (k)	2700 -7000
Power (W, LED Lamp)	27
Lifespan (hr, LED Lamp)	50,000
Application	Indoor



Integrated Omni Antenna LED Lawn Lamp Floor Mount

Antenna Type	Omni
Frequency (MHz)	698-2700 / 698-4000 / 698-6000
No of Ports	1 / 2
Connector	N or 4.3-10
Dimension (mm)	Top Cover: Ø260 Stand: Ø200 Height: 500 – 1000 (customized)
Lumen Output (lm)	2100-2300
Colour Temp (k)	2700 -7000
Power (W, LED Lamp)	5-27
Lifespan (hr, LED Lamp)	50,000
Construction	Stand: Aluminum Alloy Stand Top Cover: Fiberglass
Application	Outdoor



Remarks:

Customized designs are available on request.
Please consult Kantenna sales rep for details.

- ❖ Camouflage Housing for Concealing Antenna Line Devices
- ❖ Low Visual Impact
- ❖ Excellent Aesthetic Designs to Suit Different Scenarios

Chimney	
Material	Fiberglass
Application	Tri-sector or Omni Antennas RCU / TMA / Combiner
Dimension	300 x 300 or 600 x 600mm H = 3000mm



Tree	
Material	Fiberglass
Application	Tri-sector Antennas RCU / TMA / Combiner / CCTV
Dimension	10 to 40m



Exhaust Pipe	
Material	Fiberglass
Application	Tri-sector Antennas RCU / TMA / Combiner
Dimension	Ø400 to Ø600mm H = 1 to 3m



Remarks:
Customized designs are available on request.
Please consult Kantenna sales rep for details.

Billboard	
Material	Fiberglass
Application	Small Cell Antennas Wi-Fi Hotspots Other ALD
Dimension	Customized



Trash Bin	
Material	Fiberglass
Application	Small Cell Antennas
Dimension	Variable Designs



Spot Light	
Material	Fiberglass
Application	Integrated Directional Antenna
Dimension	Variable Designs



Lamp Pole	
Material	Steel
Application	Various ALD and Antennas Surveillance Sensors and Devices
Dimension	Variable Designs



Remarks:
Customized designs are available on request.
Please consult Kantenna sales rep for details.

- ❖ Various Tools and Wrenches
- ❖ Consumable Accessories and Materials

Besides good quality of RF components, high quality cell site installation work is equally important to ensure the performance of the network. Installation works often require special tools together with other accessories and materials to complete. KANTENNA provides suitable tools and materials for the installation work.

Basic tools: Torque Wrenches, Strippers for Feeder, etc.
Accessories: Cable Hanger, Earthing Kit, Cable Entry, etc.
Consumables: Weather Proofing Kit, Shrinkable Tube, etc.

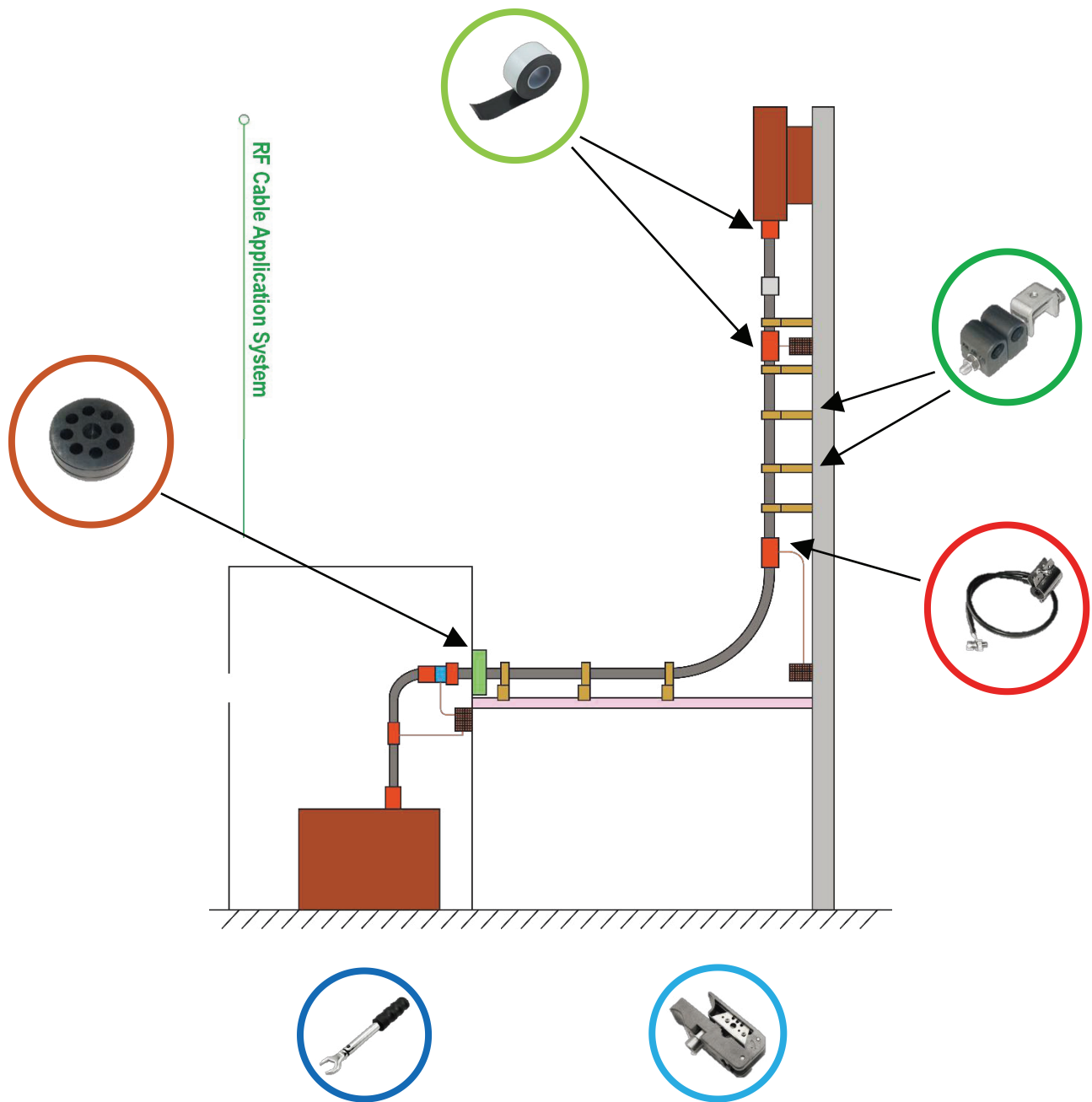



KANTENNA Technology Limited

14/F Greatmany Centre
109-115 Queen's Road East
Wan Chai, Hong Kong

www.kantennatech.com
Email: info@kantennatech.com



Content of this catalogue is subject to change without prior notice.

This catalogue shows only part of our portfolio.
Other product ranges are available.
Please contact Kantenna and its local sales reps. for details.

Your local Kantenna sales representatives:

